

Tompkins[®]

INDUSTRIES, INC.

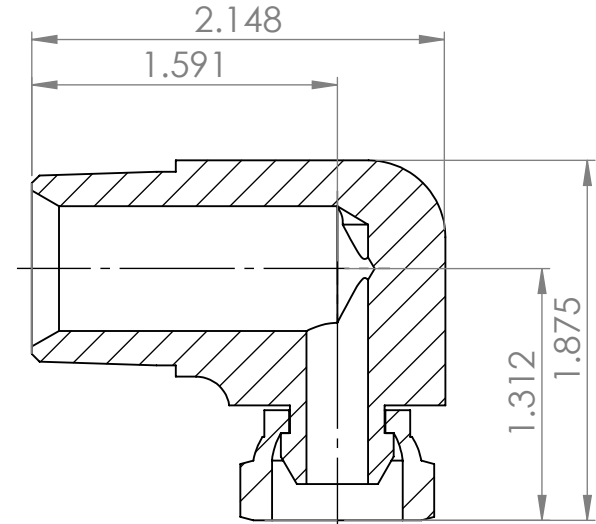
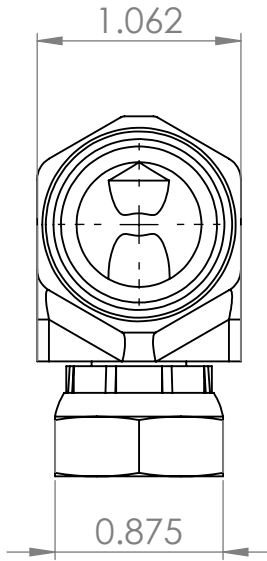

SECTION A-A

Thread 1	3/4-14	UNLESS OTHERWISE SPECIFIED: DIMENSIONS ARE IN INCHES TOLERANCES: FRACTIONAL ± ANGULAR: MACH ± BEND ± TWO PLACE DECIMAL ± THREE PLACE DECIMAL ±	NAME	DATE
Thread 2	3/8-18		DRAWN	ASW 3/20/2024
Material	Carbon Steel		CHECKED	
Oring Material	N/A		ENG APPR.	
		INTERPRET GEOMETRIC TOLERANCING PER:	MFG APPR.	
		MATERIAL	Q.A.	
		Carbon Steel	COMMENTS:	
		FINISH		
NEXT ASSY	USED ON			
APPLICATION		DO NOT SCALE DRAWING		

<https://www.tompkinsind.com/products>

TITLE:

MP x FPX 90°

SIZE	DWG. NO.	REV
A	1501-12-06	
SCALE: 1:1	WEIGHT: 0.436	SHEET 1 OF 1

PROPRIETARY AND CONFIDENTIAL
THE INFORMATION CONTAINED IN THIS DRAWING IS THE SOLE PROPERTY OF Tompkins Industries, INC. ANY REPRODUCTION IN PART OR AS A WHOLE WITHOUT THE WRITTEN PERMISSION OF Tompkins Industries, INC IS PROHIBITED.